



Sovitron Interior Pvt.Ltd.



<b>Model Name</b>	SILAS-K2201L Wall Light/ DL-OUC-K2201L-30W
<b>Description</b>	Wall light (Indirect)

Technical description	Image
-----------------------	-------

<b>Dimension</b>	L=320mm W=278mm H=45mm
<b>Frame</b>	Aluminium Die-cast
<b>Color Tempertaure</b>	3000K
<b>Power</b>	30W
<b>Total Luminous Flux</b>	2550 lm
<b>Efficacy</b>	85 lm/W
<b>IP rating</b>	65
<b>Beam angle</b>	120°
<b>Color Rendering</b>	≥80
<b>Mounting</b>	Surface
<b>Optics</b>	Clear tempered glass
<b>Dimming</b>	NON-Dimmable
<b>Operating Voltage</b>	220-240 VAC
<b>Standard Lifetime</b>	L70 minimum at 50,000 burning hours



**Dimension diagram**

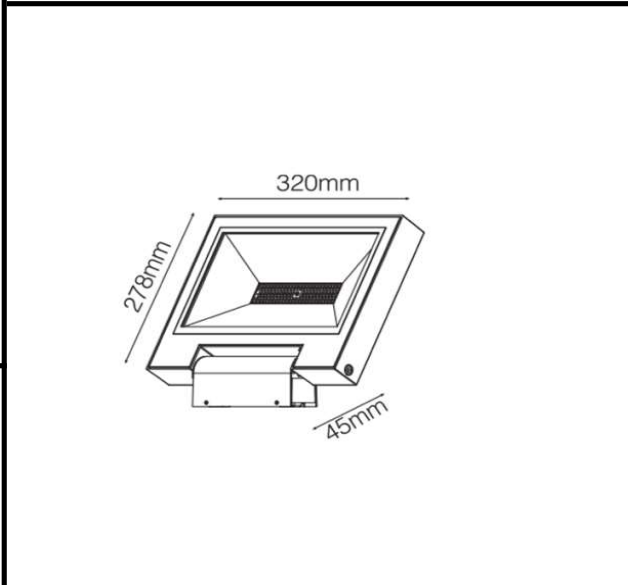

**Remarks:-**

Address: Plot #7 Saroorpur-Nangla Industrial Area,Ballabgarh-Sohna Road,Faridabad-121005  
Email: info@sovitron.com